

Article number: 204150M825D0X
 Description: E+G levelling foot
 GN 41-50-M8-25-D0-X
 Note: X With female thread, External hexagon

Measures

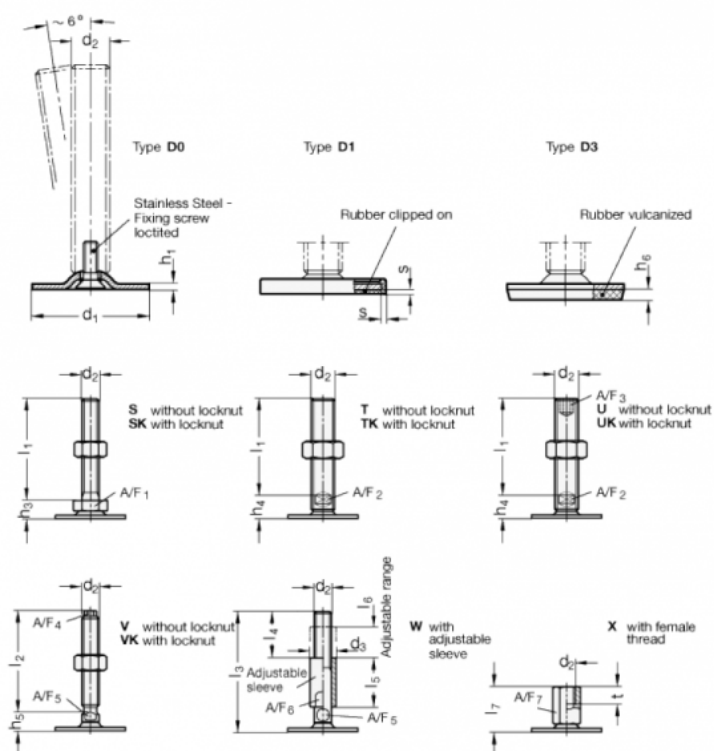

A/F7 = 14
 d1 = 50
 d2 = M8
 h1 = 2.5
 h6 =
 l7 = 25
 s =
 t = 8